The image shows a presentation board for a project named 'Carina Sinbandhit'. The board is a white rectangular panel placed on a background of architectural blueprints. To the left of the board, there are several rolls of white paper, some of which are unrolled, showing more of the blueprints. The blueprints themselves contain various architectural drawings, including floor plans with furniture like tables and chairs, and elevation drawings of a building facade with windows and a car parked in front. The text on the board is written in a black, cursive font. The overall scene is a professional architectural workspace.

*Presentation Board
Carina Sinbandhit*

house ideas

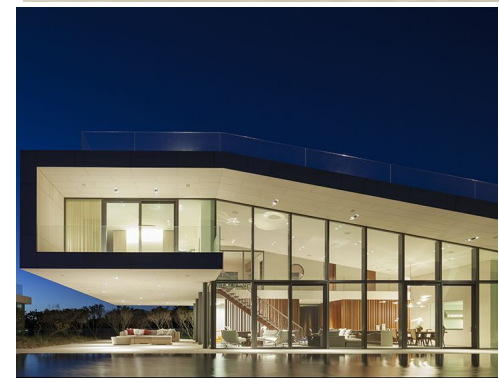

house ideas

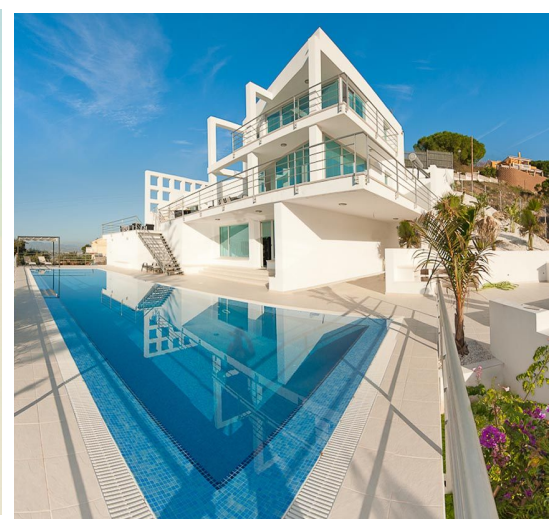
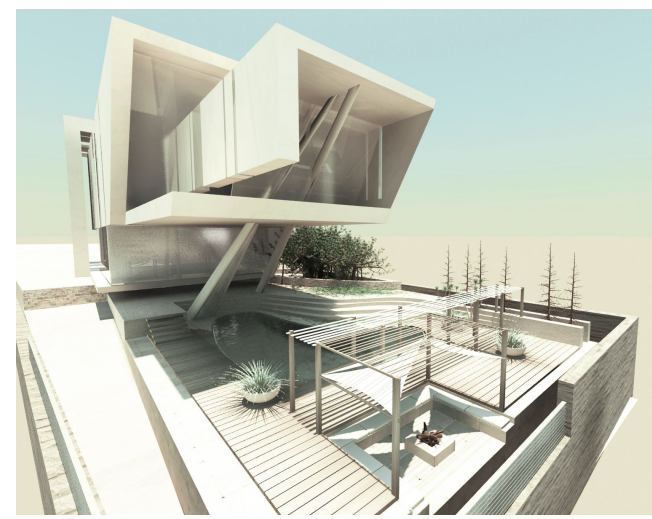

Make an irregular rectangular shaped house



house ideas



house ideas



house layout

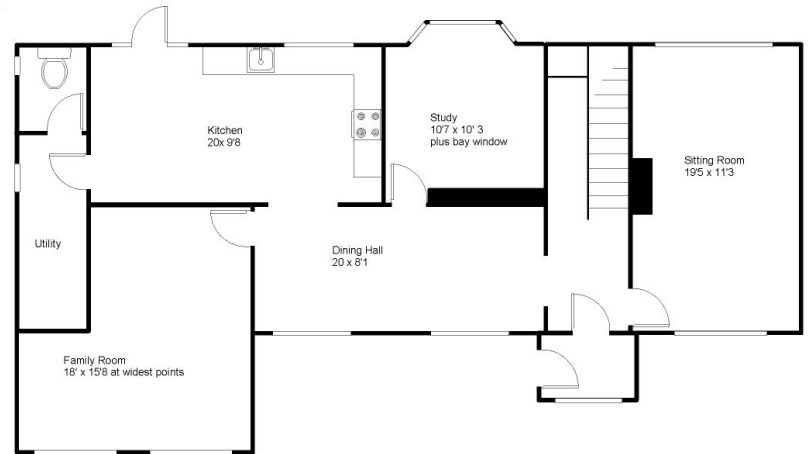
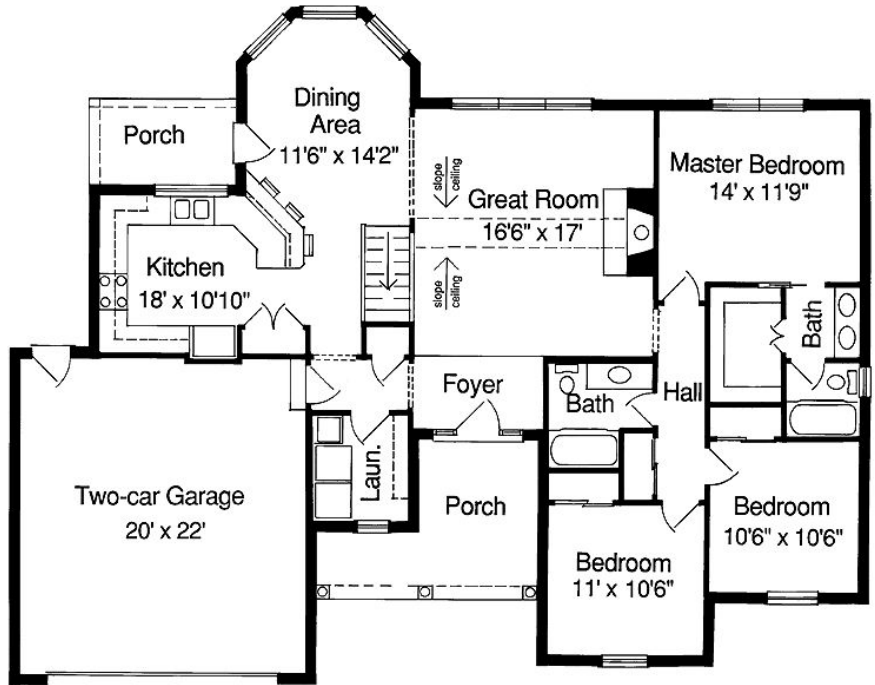
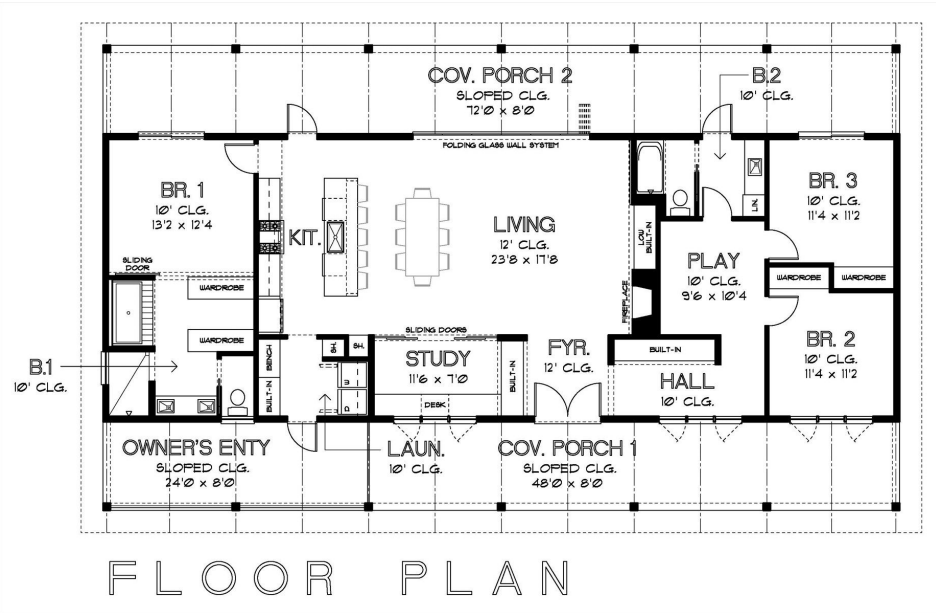

house layout

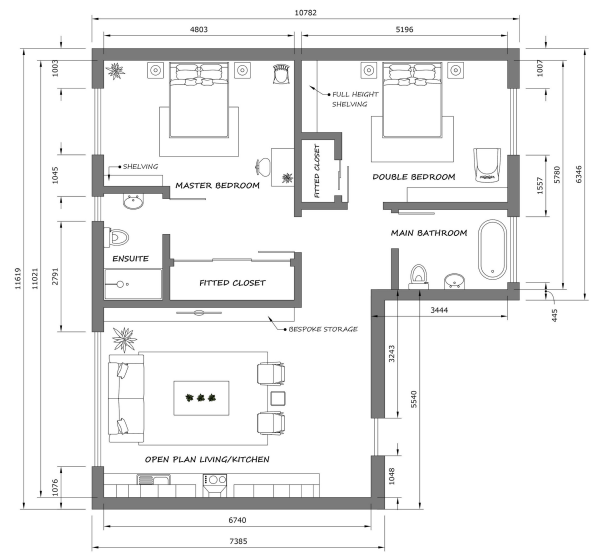
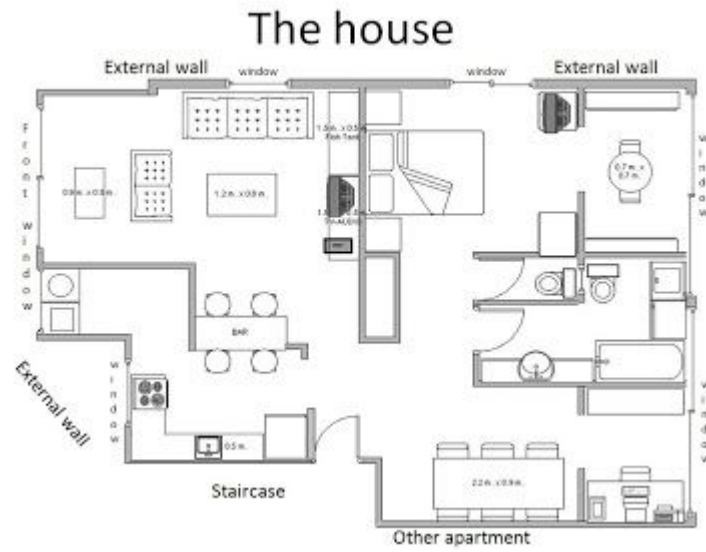
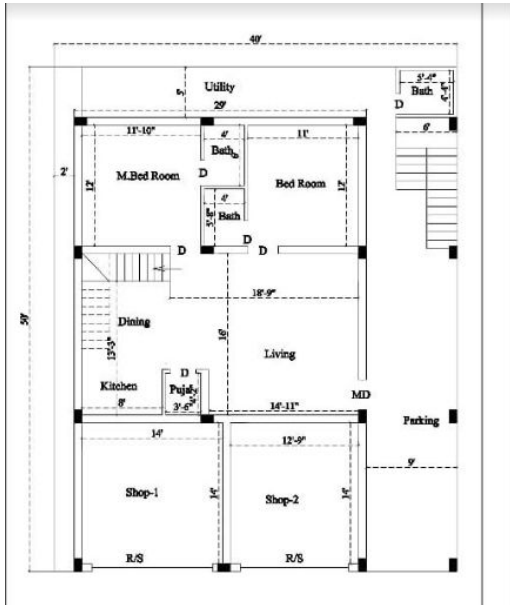

property ideas



property ideas

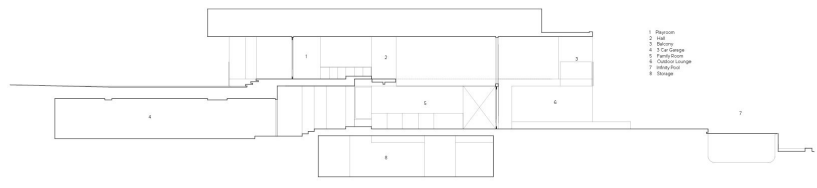

- 1. Guest Bedroom
- 2. Bedroom
- 3. Living Room
- 4. Kitchen
- 5. Dining Room
- 6. Master Suite
- 7. Bathroom
- 8. Study
- 9. Office
- 10. Storage
- 11. Carport

- 1. Entry
- 2. Living Area
- 3. Dining Area
- 4. Kitchen
- 5. Breakfast Room
- 6. Living Room
- 7. Living Room
- 8. Living Room
- 9. Living Room
- 10. Living Room
- 11. Living Room
- 12. Living Room
- 13. Living Room
- 14. Living Room
- 15. Living Room
- 16. Living Room
- 17. Living Room
- 18. Living Room
- 19. Living Room
- 20. Living Room
- 21. Living Room
- 22. Living Room
- 23. Living Room
- 24. Living Room
- 25. Living Room
- 26. Living Room
- 27. Living Room
- 28. Living Room
- 29. Living Room
- 30. Living Room
- 31. Living Room
- 32. Living Room
- 33. Living Room
- 34. Living Room
- 35. Living Room
- 36. Living Room
- 37. Living Room
- 38. Living Room
- 39. Living Room
- 40. Living Room
- 41. Living Room
- 42. Living Room
- 43. Living Room
- 44. Living Room
- 45. Living Room
- 46. Living Room
- 47. Living Room
- 48. Living Room
- 49. Living Room
- 50. Living Room

- 1. Master Suite
- 2. Master Bedroom
- 3. Master Bath
- 4. Master Closet
- 5. Young Adult Suite
- 6. Bedroom
- 7. Bedroom
- 8. Bedroom
- 9. Bedroom
- 10. Bedroom
- 11. Bedroom
- 12. Bedroom
- 13. Bedroom
- 14. Bedroom
- 15. Bedroom
- 16. Bedroom
- 17. Bedroom
- 18. Bedroom
- 19. Bedroom
- 20. Bedroom
- 21. Bedroom
- 22. Bedroom
- 23. Bedroom
- 24. Bedroom
- 25. Bedroom
- 26. Bedroom
- 27. Bedroom
- 28. Bedroom
- 29. Bedroom
- 30. Bedroom
- 31. Bedroom
- 32. Bedroom
- 33. Bedroom
- 34. Bedroom
- 35. Bedroom
- 36. Bedroom
- 37. Bedroom
- 38. Bedroom
- 39. Bedroom
- 40. Bedroom
- 41. Bedroom
- 42. Bedroom
- 43. Bedroom
- 44. Bedroom
- 45. Bedroom
- 46. Bedroom
- 47. Bedroom
- 48. Bedroom
- 49. Bedroom
- 50. Bedroom

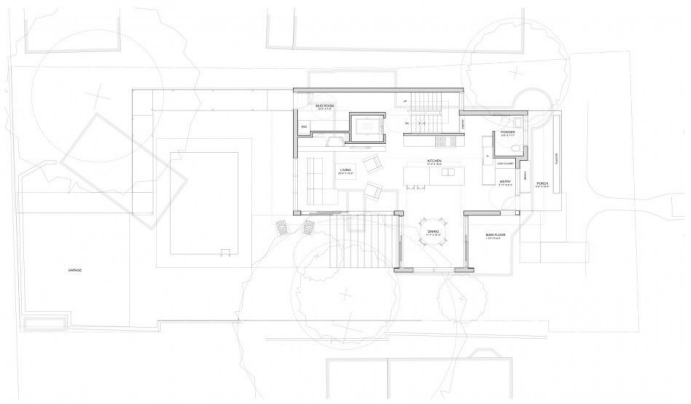
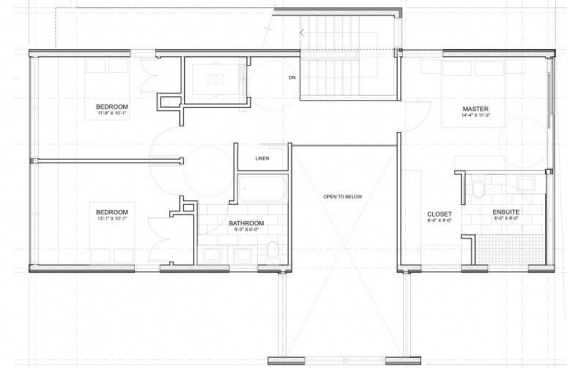
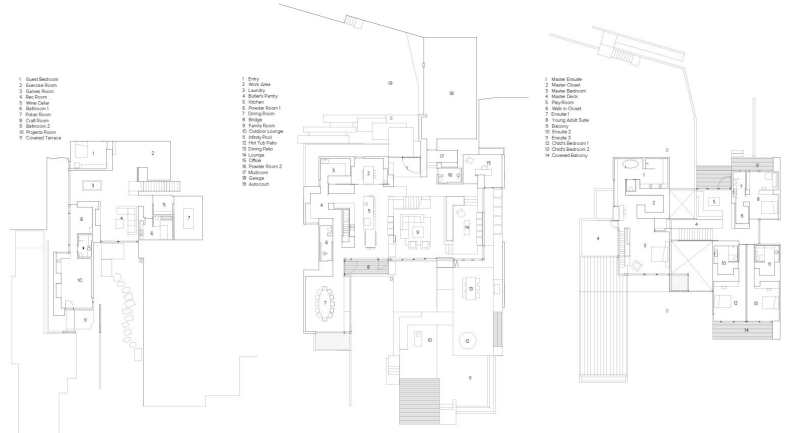

kitchen ideas



kitchen ideas



kitchen layouts

Q: What does the triangle represent in the diagrams?

A: The idea behind the kitchen work triangle is to clearly mark out distinct spaces (or 'work centres') for each of these fundamental tasks, and to plan an ergonomic work area to reduce the distance and effort required to work effectively in the kitchen.

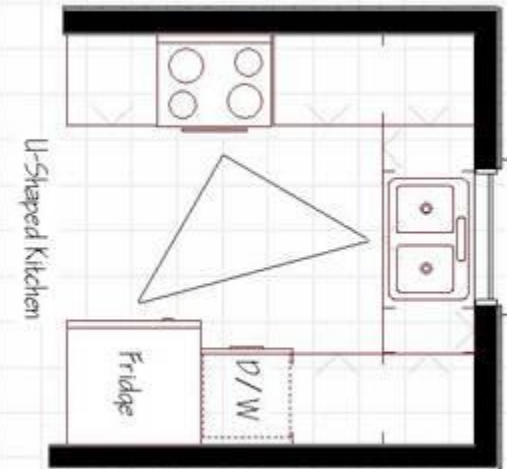
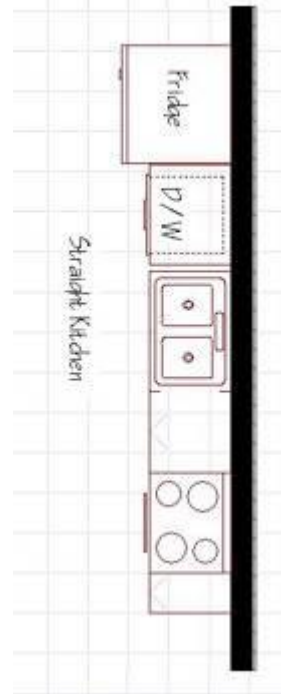
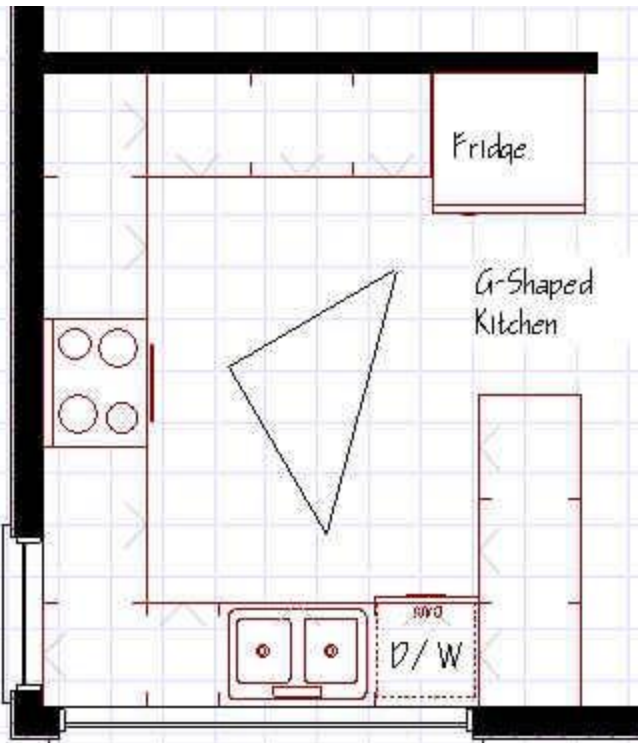
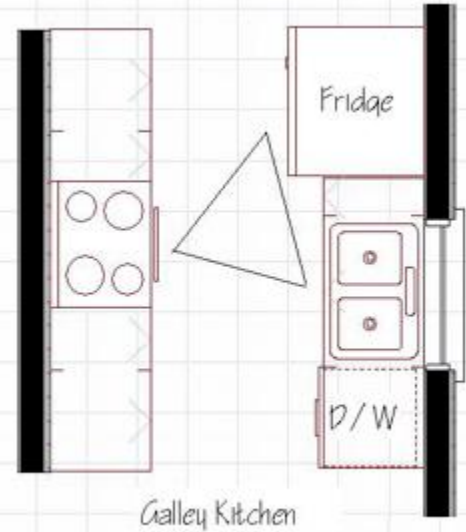
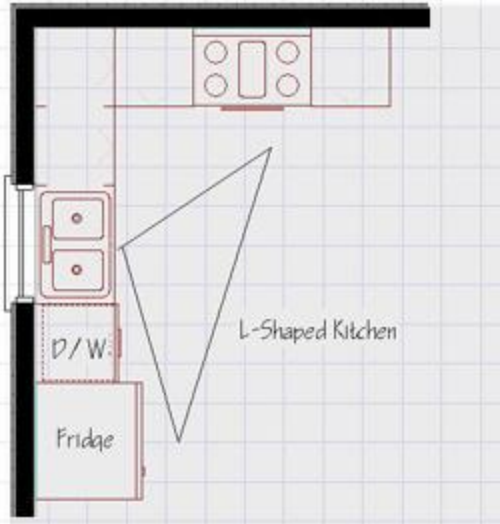

Make approximately 16ft by 15ft
Sunrise/sets from the southwest

bathroom ideas



bathroom ideas

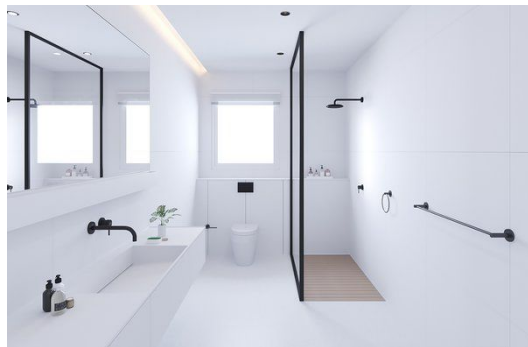

bathroom layouts

Make approximately 12.5ft by 10ft

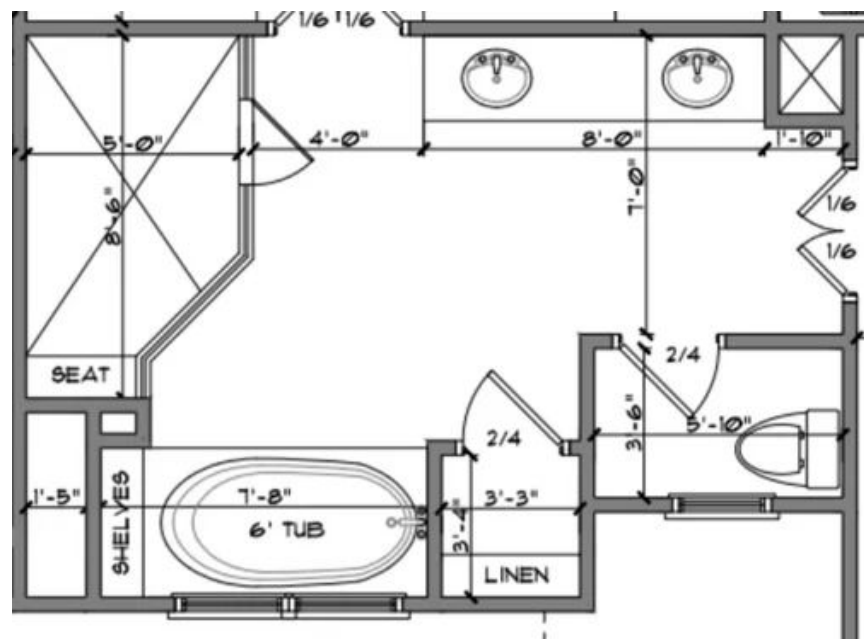
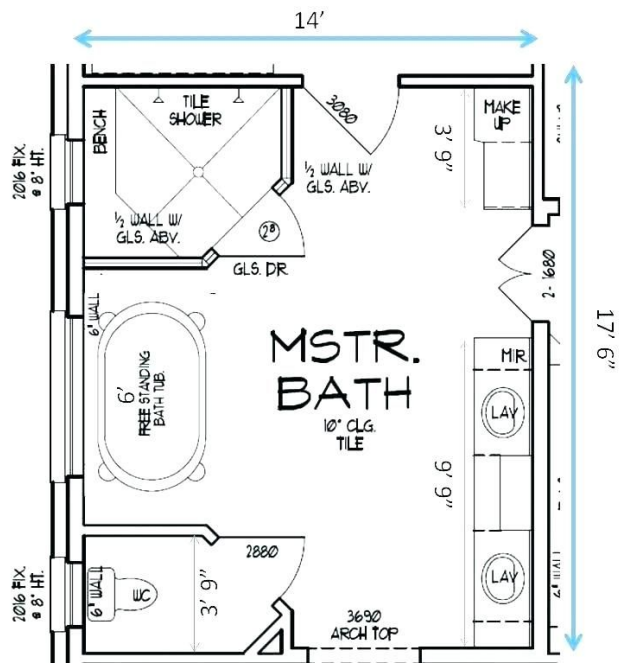
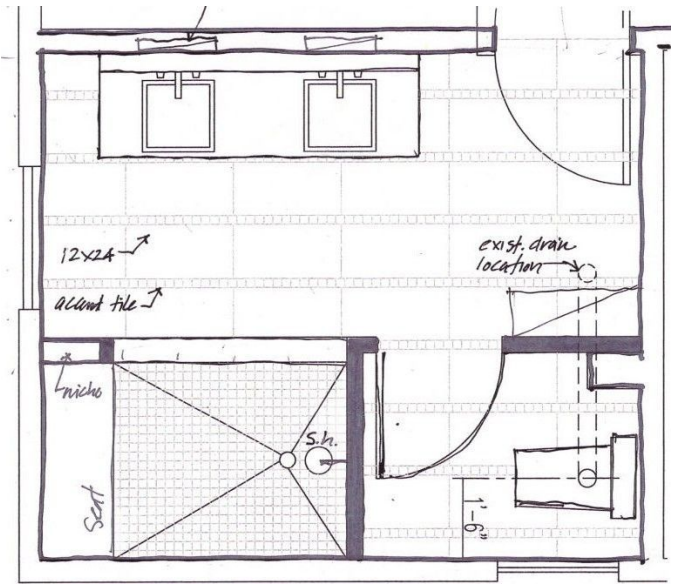
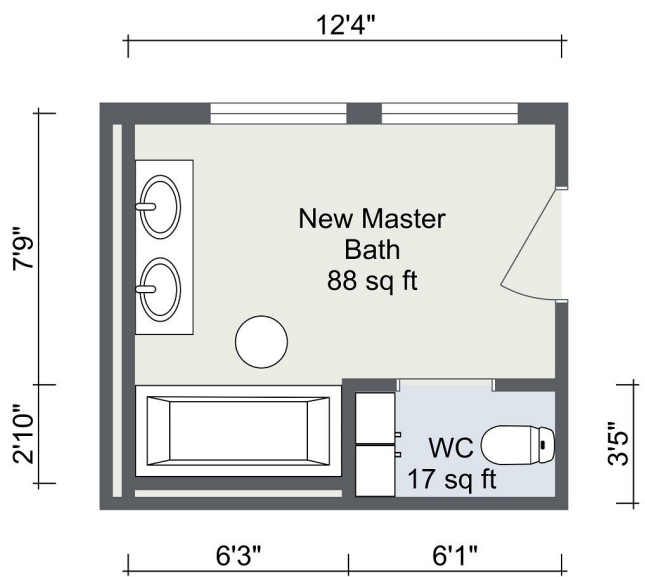

bedroom ideas



bedroom ideas

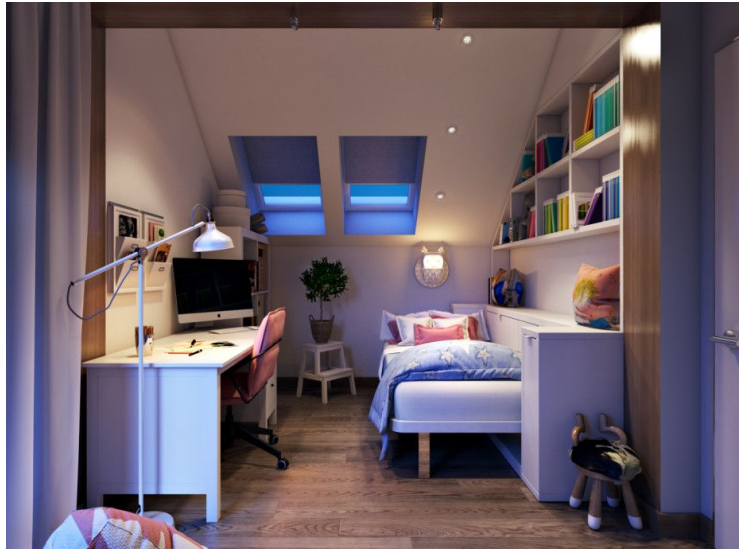

bedroom layouts



131 ft² | 12.1 m²

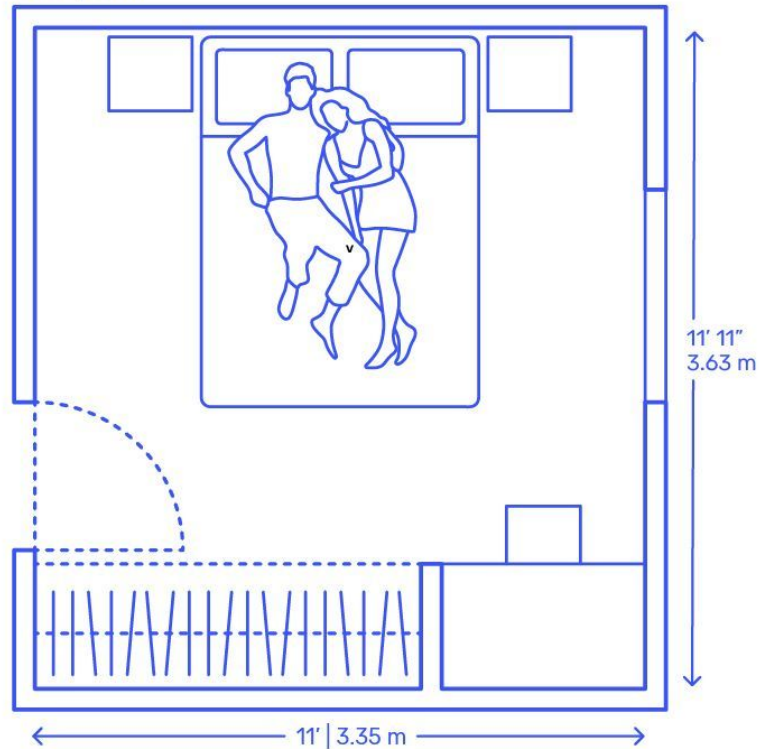

Make masters: approximately 14.8ft by 16.5ft
Guest: approximately 12ft by 11ft

living room idea

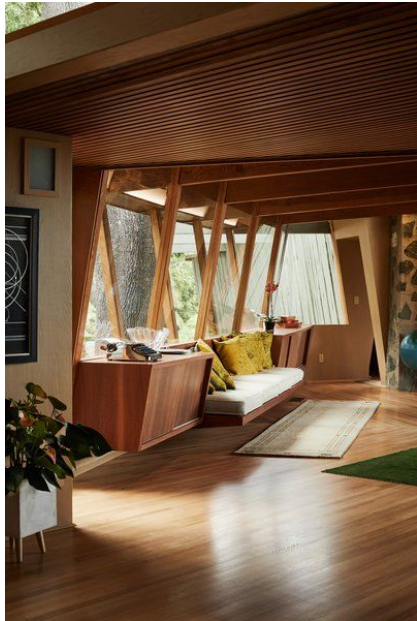
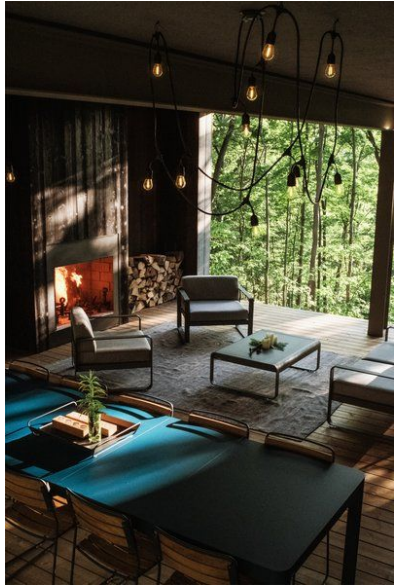

living room idea



living room idea



living room layouts

Make approximately 14.8ft by 24.5ft

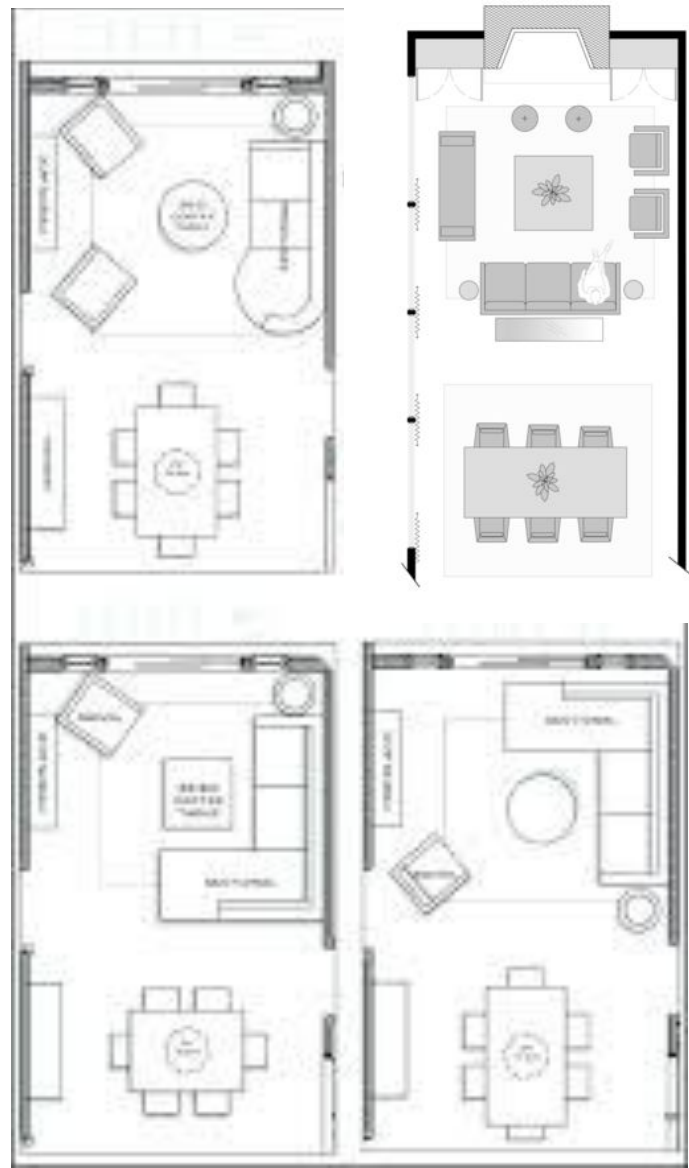
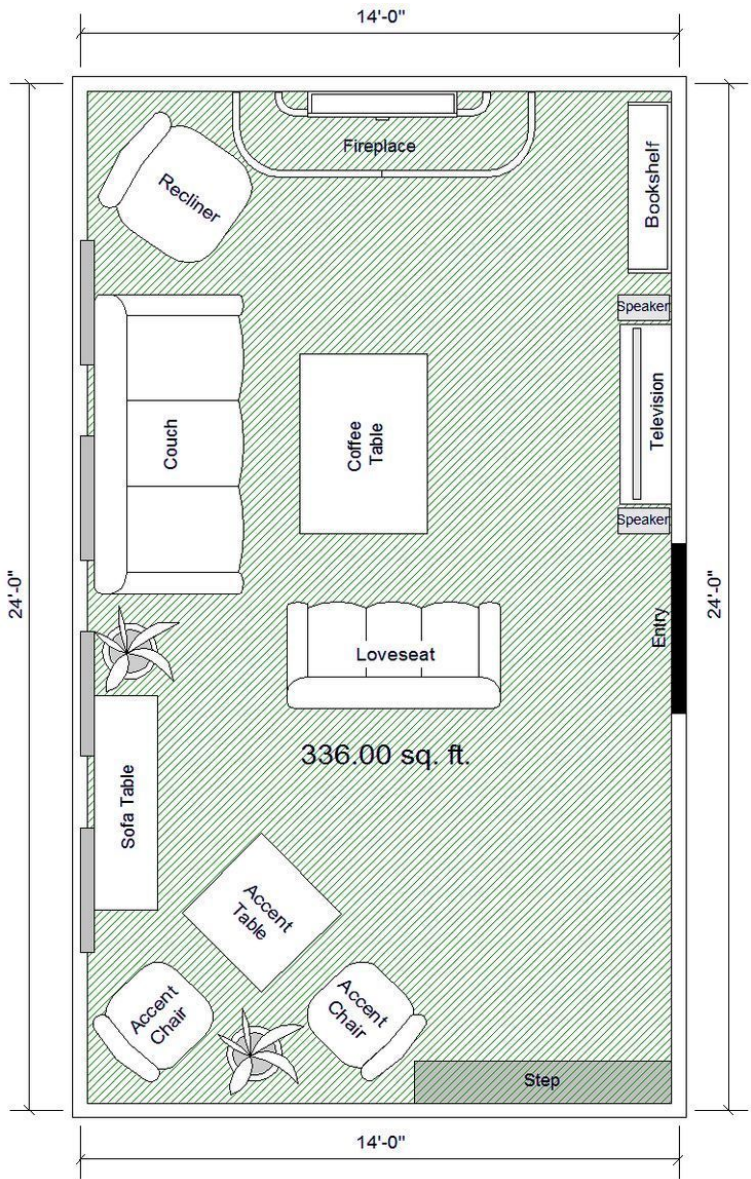

alternative energy ideas



Microhydro Electricity



Solar Energy



Solar/Wind Hybrid System



Wind Energy



Geothermal Heat Pump

alternative energy ideas



Pacific Ocean



Shinagawa Incineration Plant



The Ebie Sewage Treatment Plant

- For Human Waste
- Ocean
- River
- Sewage Treatment Plant
- For Garbage, Compost and Recycle

environmentally sustainable materials

Bamboo



Wood

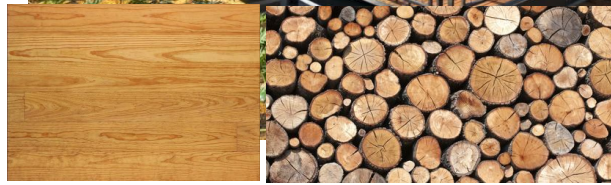

Recycled Plastic



HempCrete



Mycelium



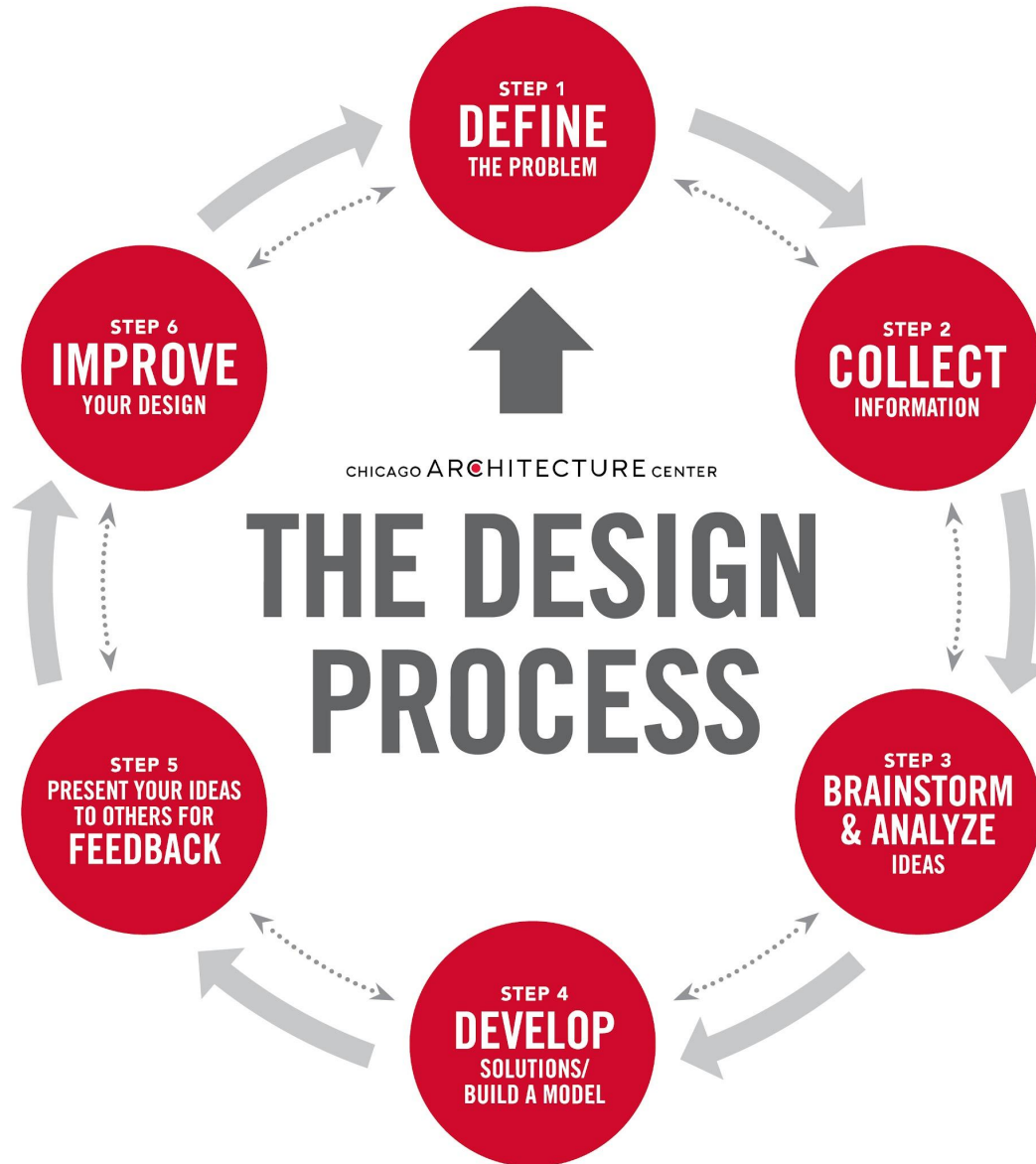

Ex.,

